



AQUA 12S

FREESTANDING DISHWASHER



Juggling numerous tasks at home and work can be a bit overwhelming especially when you do not have the right appliances that help take care of your daily mundane activities at home. Häfele's premium appliances range equips you with the choice of concentrating on activities that really need your attention. With our range of appliances you can go about your day without the added stress of doing that big batch of laundry or cleaning your utensils. Häfele now introduces Aqua 12S - a new freestanding dishwasher which is a hygienic and quiet alternative to your regular washing.

This dishwasher has an impressive capacity with a 12 place setting, aptly suited for an average Indian household. The adjustable upper and lower baskets along with the separate cutlery basket guarantee maximum space optimization inside the dishwasher! Besides, it also has the option of functioning at half load, which is an energy saving solution when you have less dishes to wash! The SoftTouch shelves of the dishwasher prevent scraping and scratching of utensils thus leading to a long life of your precious china.

The new Aqua 12S Dishwasher comes with built-in programs which provide you with the flexibility of washing your dishes depending on their material and how soiled they are. There is a glass care program especially designed for your delicate glassware and an intensive program to take care of the toughest stains on your pots and kadhais. The temperatures and time duration for different programs vary according to the dishes you choose, such as pots, glasses, plates etc., ensuring 99.9% germ-free cleaning of any utensil you put inside. Each washing cycle is followed by an efficient drying cycle which gives you dishes which are ready-to-use.

To keep your dishwasher safe from prying hands, you can turn on the child lock to block the usage of the control panel. The sound engineering technology of this dishwasher doesn't cause a disturbance in the background when all you want to do is spend some time with your family or take an afternoon siesta!

Time and peace are luxuries you can now afford with Häfele's new Aqua 12S Dishwasher!

FEATURES

Low Water Consumption

Washing dishes by hand may feel like an achievement, but the environment ends up paying a price for it. Washing dishes by hand consumes more litres of water for the same load that can be cleaned with as little as 11 litres of water using Häfele's Aqua 12 S Dishwasher.



99.9% Germ-free Cleaning

It isn't enough that your dishes are visibly clean, they need to be germ-free too! The Aqua 12S Dishwasher delivers a hygienic wash capable of eliminating 99.9% germs and bacteria. The high temperature inside the dishwasher accompanied with the water pressure removes all the sticky residue, bacteria and germs.



No More Wet Utensils

The drying cycle in the Aqua 12S Dishwasher leaves your dishes perfectly dry without any water residue or moisture deposit!

The residual drying technology incorporated in Aqua 12S dries the dishes with the help of the steam is generated during the washing cycle without the introduction of external air. As a result, the drying is faster and more hygienic compared to other drying methods.



Glass Care Program

The most delicate things need the greatest care. With our Aqua 12S Dishwasher, your glassware have a dedicated glass care program which is a 40 °C, 60 minute gentle cycle. Now your champagne flutes, wine glasses and glass bowls will get the best treatment possible!



 **Pro-tip:** To maintain the shine and texture of your glassware, increase the amount of rinse-aid than what you would normally add.

Additional Cutlery Basket

Your cutlery usually gets lost in the sea of larger utensils when placed in the same basket. To make sure that these small but essential tableware are looked after properly, Aqua 12S provides you with a dedicated cutlery basket which offers you immense flexibility and convenience to take good care of your knives, spoons and forks.



SoftTouch Shelves

The racks and spikes in the Aqua 12S Dishwasher are coated with nylon which provides a gentle hold for fragile glassware and essential crockery during active washing and drying cycles. Moreover, compared to normal racks, these racks are more hygienic and last longer.



FEATURES

High Capacity

The new Aqua 12S Dishwasher has an impressive capacity with a 12-place setting. This is enough not only for an average Indian family but also for when there are guests over. The loading capacities and position of different utensils in the lower and upper baskets are demonstrated below. To accommodate taller utensils, cooking pots, *kadhais* and woks, the spikes in the lower basket can be folded and racks in the upper basket can be adjusted or removed.

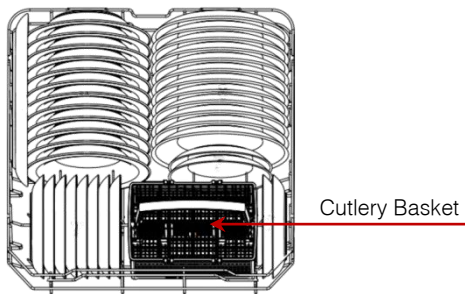
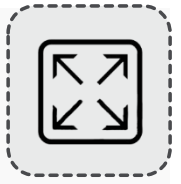

Lower Basket Loading

- 12 Dessert Dishes
- 12 Dinner Plates
- 12 Soup Plates
- 1 Big Oval Rice Plate



Cutlery Basket Loading

- 12 Soup Spoons
- 12 Forks
- 12 Knives
- 12 Tea Spoons
- 12 Dessert Spoons
- 2 Serving Spoons
- 1 Serving Fork
- 1 Gravy Ladle

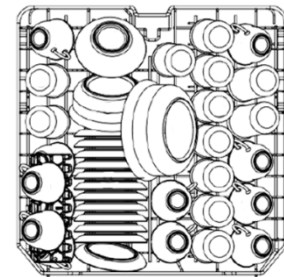

Upper Basket Loading

- 12 Cups
- 12 Saucers
- 12 Glasses
- 1 Regular Serving Bowl
- 3 Medium Serving Bowls
- 3 Big Serving Bowls

Sound Engineered

You wouldn't want the humming of the dishwasher to affect your quiet afternoon siesta or your post dinner conversations. Häfele's new Aqua 12S Dishwasher has been designed keeping this in mind. The sound reducing material, massive insulation, quality of components and the science of hydraulics integrated within the Aqua 12S Dishwasher ensures silent washing and drying cycles.



Half Load

The Half Load function in Aqua 12S lets you wash half the capacity of utensils, perfect for small households. This feature helps save 20% more water and 10% more energy as compared to operating the dishwasher on full load.



Sensor for Water Pressure

The sensor in the dishwasher detects the spray intensity and water quantity at all times and in case there is a perceived loss in either, the dishwasher immediately compensates it by ensuring optimal circulation of water. The ideal quantity of water that should be present in the dishwasher at a time is determined by the program that is selected.



Effective Filtration System

Häfele's Aqua 12S Dishwasher has a three-fold filtration system: Coarse Filter, Fine Filter and Micro Filter. These filters efficiently work together to prevent all food particles and solid residue from flowing into the drainage system which protects your drainage pipe from clogging and ensuring efficient circulation of water. Since water is continuously drained out, the volume of water inside the dishwasher is always maintained at an optimal level, enabling the spray arms to spray water at the required intensity to clean the dishes. The filters need to be cleaned regularly for them to perform at their optimal level.

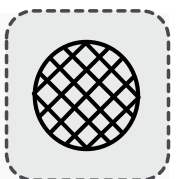

FEATURES

Intensive Program

For the Indian style of cooking which entails a lot of frying and tempering, Aqua 12S offers an intensive program which takes care of your highly soiled cooking utensils, pots and pans and removes the most stubborn oil stains. When the dishwasher is operated in the intensive program, the items in the lower rack are subjected to 20% spray pressure at a higher temperature as compared to the 15% spray pressure at lower temperatures in other programs. The upper rack is subjected to the same amount of pressure as that in other programs.



Leak-proof

Häfele's Aqua 12S Dishwasher gives you a 100% leak proof guarantee. If ever a leak occurs, the water pressure sensor shuts down the dishwasher automatically preventing any further damage.



Child Lock

You can't control children from being curious and fidgeting with things, but you can make your dishwasher secure with the help of the child lock feature available in Aqua 12S. Child lock prevents people who are unaware about the function of the dishwasher from accidentally opening the door or changing the program when it is in use.



CONTROLS AND OPERATION



- 1 Power Button
- 2 Half Load
- 3 Delayed Start
- 4 Program Selector
- 5 Start/Pause
- 6 Child Lock

1 Power Button

To start the dishwasher, you need to press the power button. When the dishwasher is switched on, the LED indicator above the button switches on.

2 Half Load

You don't need to wait for a full load of utensils to start washing your dishes. The half load function is a great energy, time and water saving solution for small loads of dishes. Unlike the standard half load function present in the other dishwashers available in the market which only activates the spray zones of the bottom racks, the half load function in the Aqua 12S Dishwasher can activate either one of the racks. Thus, you can choose a rack depending on the type of utensils you intend to wash.

3 Delayed Start

Don't want your dishes to be washed and kept in the dishwasher for a long time before you arrive home? The delayed start function helps you to set the time at which you want your washing to begin. Press the button multiple times to delay the time of the wash program by 3/6/9 hours accordingly.

4 Program Selector

Washing habits depend on eating and cooking routines and the lifestyle of an individual. The new Aqua 12S Dishwasher comes with 6 different washing programs offering you a range of dishwashing choices. Press the program selector button multiple times to select the program that would best suit your need! (*more info about this on the next page*)

CONTROLS AND OPERATION

5 Start / Pause

After you have selected your desired washing program, start time and full/half load; you can confirm and start the cycle by pressing the start button. You can also pause the cycle in between by pressing the same button.

6 Child Lock

To activate child lock, press and hold the 'Delayed Start' and 'Program Selector' buttons together for 3 seconds. This will lock all the buttons on the control panel – except the power button to avoid any accidental tampering during washing cycle. To unlock the function, repeat the same procedure.

PROGRAMS AND APPLICATION

The Aqua 12S Dishwasher is equipped with 6 different programs to take care of all your washing needs. Details of the programs are given below.

ECO

ECO

- > Most economical program for medium soiled daily dishes
- > Cycle: Pre-wash → Wash (45 °C) → Rinse (65 °C) → Dry
- > Degree of Soiling: Medium
- > Wash Time: 190 mins
- > Power Consumption: 0.90 kWh
- > Water Consumption: 11 L

RAPID 30



- > Suitable for lightly soiled daily dishes that are scraped or pre-cleansed
- > Cycle: Wash (45 °C) → 2 × Rinse (55 °C)
- > Degree of Soiling: Low
- > Wash Time: 30 mins
- > Power Consumption: 0.75 kWh
- > Water Consumption: 11 L

INTENSIVE



- > Designed for highly soiled wash loads, such as pots, serving utensils and woks
- > Cycle: Pre-wash (50 °C) → Wash (60 °C) → 3 × Rinse (70 °C) → Dry
- > Degree of Soiling: High
- > Wash Time: 170 mins
- > Power Consumption: 1.6 kWh
- > Water Consumption: 18 L

NORMAL



- > Ideal for daily wash of a load of utensils used for regular cooking which are medium-high soiled
- > Cycle: Pre-wash (45 °C) → Wash (55 °C) → 2 × Rinse (65 °C) → Dry
- > Degree of Soiling: Medium-High
- > Wash Time: 180 mins
- > Power Consumption: 1.3 kWh
- > Water Consumption: 15 L

90 MINS WASH



- > For medium soiled loads that do not need excellent drying efficiency
- > Cycle: Wash (65 °C) → 2 × Rinse (65 °C) → Dry
- > Degree of Soiling: Medium
- > Wash Time: 90 mins
- > Power Consumption: 1.02 kWh
- > Water Consumption: 12 L

GLASS



- > For delicate glassware like bowls, plates, wine glasses, etc.,
- > Cycle: Pre-wash (30 °C) → Wash (40 °C) → 2 × Rinse (60 °C) → Dry
- > Degree of Soiling: Light
- > Wash Time: 60 mins
- > Power Consumption: 0.9 kWh
- > Water Consumption: 14 L

Note:

- Use dishwasher detergent for effective washing of the dishes
- Ensure that the slots for salt, detergent and rinse-aid are filled before starting any program
- When washing glassware, add more rinse-aid than normally required for other utensils

IMPORTANT INFORMATION

Changing the program in the middle of the cycle

A wash cycle can only be changed if it has been running for a short time. Otherwise, the detergent may have already been released and the dishwasher may have already drained the wash water. If this is the case, then the dishwasher needs to be reset and the detergent dispenser must be refilled. To reset the dishwasher, follow the instructions below:

- Press the start/pause button for more than 3 seconds. This will cancel the program.
- Press the program selector button to select the desired program.
- Press the start/pause button. After 10 seconds, the dishwasher will start in the new program.

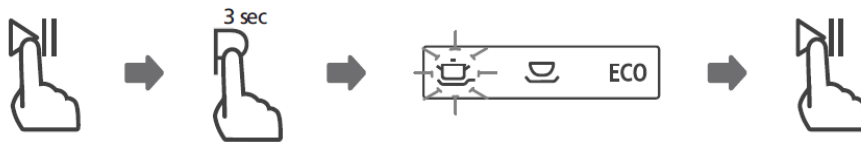

Adding a utensil after the wash cycle starts

You can add a forgotten utensil any time before the detergent dispenser opens (within 30 seconds of starting the cycle). The instructions for the same are given below:

- Press the start/pause button to pause the washing.
- Wait for 5 seconds; then open the door.
- Add the forgotten dishes and close the door.
- Press the start/pause button. After 10 seconds, the dishwasher will restart.

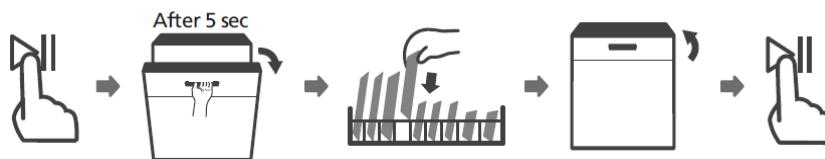

SAFETY INSTRUCTIONS

- Do not operate your dishwasher unless all enclosure panels are properly in place
- Open the door very carefully if the dishwasher is operating, there is a risk of water squirting out
- Knives and other utensils with sharp edges must be placed in the basket with their pointed ends facing down or in a horizontal position
- Check that the detergent powder is empty after the completion of wash cycle
- Do not wash plastic utensils/containers unless they are marked 'dishwasher safe'
- The salt container must only be refilled when the salt warning light (☹) in the control panel comes on. If the salt has spilled, run a quick program ('RAPID 30') to remove it
- If cleaning of the doors or control panel is required, clean with a soft damp cloth only
- Check the condition of the filters regularly and clean them if necessary under running water. While placing the filters back in the dishwasher follow the proper sequence ; coarse → fine → micro (from top)
- After every wash, turn off the power supply and leave the door of the dishwasher slightly open so that moisture and odours are not trapped inside
- Allow your dishes to cool for 15 minutes with the door open and then unload the dishes beginning with the lower basket

PRODUCT SPECIFICATIONS

- > **Article No: 539.20.550**
- > Freestanding Dishwasher
- > Material: Stainless Steel (Drum) and Mild Steel (Exterior)
- > Finish: Silver
- > Capacity: 12 Place Settings
- > Energy Consumption (kWh): 258
- > Water Consumption (ECO program): 11 L/Cycle
- > Energy Efficiency: A++
- > Drying Efficiency: A
- > Noise Level: 49 dBA
- > Push Button Functions:
 - > *On/Off*
 - > *Start/Pause*
 - > *Delayed Start*
 - > *Half Load*
 - > *Child Lock*
- > Functions of Indicator:
 - > *Program*
 - > *Salt (when the quantity of salt falls below the minimum required level, this indicator switches on)*
 - > *Low Rinse Aid*
 - > *Child Lock*
 - > *Half Load*
 - > *Delayed Start (3/6/9 hours)*
- > Programs
 - > *Eco*
 - > *Rapid 30*
 - > *Intensive*
 - > *Normal*
 - > *90 mins wash*
 - > *Glass*

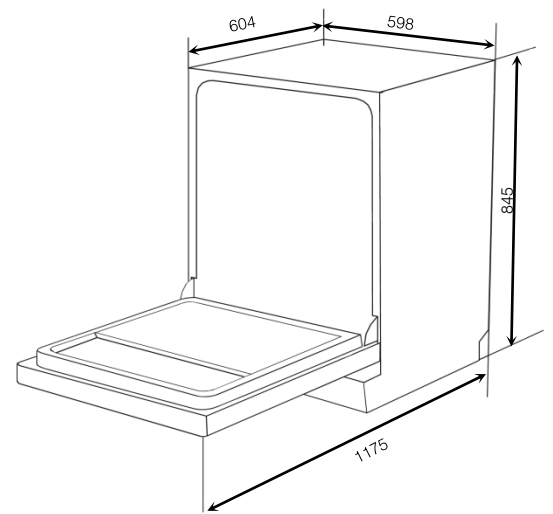

HÄFELE

Häfele India Private Limited

Office No. 3, Building "A", BETA, I Think
Techno Campus, Off J.V.L.R, Opp.
Kanjurmarg East, Mumbai – 400 042.
Phone: 022 6142 6100 | **Fax:** 022 6702 0531.

New Delhi | Kolkata | Cochin | Chennai |
Hyderabad | Bangalore | Mumbai | Pune |
Ahmedabad | Srilanka | Bangladesh | Nepal |
Bhutan | Maldives

Toll Free Customer Care No.: 1800 266 6667
Customer Care WhatsApp No.: +91 9769111122
SMS HAFELE to 56070
info@hafeleindia.com
customercare@hafeleindia.com

